

HiPerFAST™ IGBT with Diode

C2-Class High Speed IGBTs

IXGK 60N60C2D1
IXGX 60N60C2D1

$V_{CES} = 600 \text{ V}$
 $I_{C25} = 75 \text{ A}$
 $V_{CE(sat)} = 2.5 \text{ V}$
 $t_{fi(typ)} = 35 \text{ ns}$

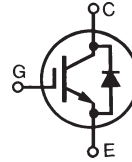

Symbol	Test Conditions	Maximum Ratings	
V_{CES}	$T_J = 25^\circ\text{C to } 150^\circ\text{C}$	600	V
V_{CGR}	$T_J = 25^\circ\text{C to } 150^\circ\text{C}; R_{GE} = 1 \text{ M}\Omega$	600	V
V_{GES}	Continuous	± 20	V
V_{GEM}	Transient	± 30	V
I_{C25}	$T_C = 25^\circ\text{C}$ (limited by leads)	75	A
I_{C110}	$T_C = 110^\circ\text{C}$	60	A
I_{F110}	$T_C = 110^\circ\text{C}$	48	A
I_{CM}	$T_C = 25^\circ\text{C}, 1 \text{ ms}$	300	A
SSOA (RBSOA)	$V_{GE} = 15 \text{ V}, T_{VJ} = 125^\circ\text{C}, R_G = 10 \Omega$ Clamped inductive load @ $V_{CE} \leq 600 \text{ V}$	$I_{CM} = 100$	A
P_c	$T_C = 25^\circ\text{C}$	480	W
T_J		-55 ... +150	$^\circ\text{C}$
T_{JM}		150	$^\circ\text{C}$
T_{stg}		-55 ... +150	$^\circ\text{C}$
M_d	Mounting torque, TO-264	1.13/10 Nm/lb.in.	
Weight	TO-264	10	g
	PLUS247	6	g
Maximum lead temperature for soldering 1.6 mm (0.062 in.) from case for 10 s		300	$^\circ\text{C}$

TO-264 AA
(IXGK)

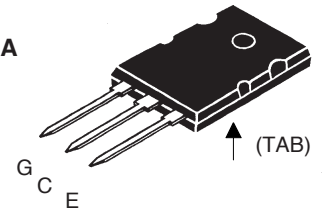

PLUS247
(IXGX)

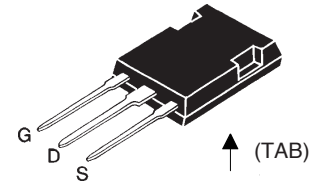

G = Gate C = Collector
E = Emitter Tab = Collector

Features

- Very high frequency IGBT and anti-parallel FRED in one package
- Square RBSOA
- High current handling capability
- MOS Gate turn-on for drive simplicity
- Fast Recovery Epitaxial Diode (FRED) with soft recovery and low I_{RM}

Applications

- Switch-mode and resonant-mode power supplies
- Uninterruptible power supplies (UPS)
- DC choppers
- AC motor speed control
- DC servo and robot drives

Advantages

- Space savings (two devices in one package)
- Easy to mount with 1 screw

Symbol	Test Conditions	Characteristic Values ($T_J = 25^\circ\text{C}$ unless otherwise specified)		
		Min.	Typ.	Max.
$V_{GE(th)}$	$I_C = 250 \mu\text{A}, V_{CE} = V_{GE}$	3.0		5.0 V
I_{CES}	$V_{CE} = V_{CES}$ $V_{GE} = 0 \text{ V}$			$T_J = 25^\circ\text{C}$: 650 μA $T_J = 125^\circ\text{C}$: 5 mA
I_{GES}	$V_{CE} = 0 \text{ V}, V_{GE} = \pm 20 \text{ V}$			$\pm 100 \text{ nA}$
$V_{CE(sat)}$	$I_C = 50 \text{ A}, V_{GE} = 15 \text{ V}$ Note 1		$T_J = 25^\circ\text{C}$: 2.1 $T_J = 125^\circ\text{C}$: 1.8	2.5 V V

Symbol	Test Conditions	Characteristic Values ($T_J = 25^\circ\text{C}$ unless otherwise specified)		
		Min.	Typ.	Max.
g_{fs}	$I_C = 50\text{ A}; V_{CE} = 10\text{ V}$, Note 1	40	58	S
C_{ies}	$V_{CE} = 25\text{ V}, V_{GE} = 0\text{ V}, f = 1\text{ MHz}$		3900	pF
C_{oes}			280	pF
C_{res}			97	pF
Q_g	$I_C = 50\text{ A}, V_{GE} = 15\text{ V}, V_{CE} = 0.5 V_{CES}$		146	nC
Q_{ge}			28	nC
Q_{gc}			50	nC
$t_{d(on)}$	Inductive load, $T_J = 25^\circ\text{C}$ $I_C = 50\text{ A}, V_{GE} = 15\text{ V}$ $V_{CE} = 400\text{ V}, R_G = R_{off} = 2.0\ \Omega$		18	ns
t_{ri}			25	ns
$t_{d(off)}$			95	150 ns
t_{fi}			35	ns
E_{off}			0.48	0.8 mJ
$t_{d(on)}$	Inductive load, $T_J = 125^\circ\text{C}$ $I_C = 50\text{ A}, V_{GE} = 15\text{ V}$ $V_{CE} = 400\text{ V}, R_G = R_{off} = 2.0\ \Omega$		18	ns
t_{ri}			25	ns
E_{on}			0.9	mJ
$t_{d(off)}$			130	ns
t_{fi}			80	ns
E_{off}		1.2	mJ	
R_{thJC}			0.26	KW
R_{thCK}		0.15		KW

Reverse Diode (FRED)

Symbol	Test Conditions	Characteristic Values ($T_J = 25^\circ\text{C}$, unless otherwise specified)		
		min.	typ.	max.
V_F	$I_F = 60\text{ A}, V_{GE} = 0\text{ V}$, Note 1			2.1 V
		$T_J = 150^\circ\text{C}$		1.4
I_{RM}	$I_F = 60\text{ A}, V_{GE} = 0\text{ V}, -di_F/dt = 100\text{ A}/\mu\text{s}$ $V_R = 100\text{ V}$			8.3 A
t_{rr}	$I_F = 1\text{ A}; -di/dt = 200\text{ A/ms}; V_R = 30\text{ V}$		35	ns
R_{thJC}				0.65 KW

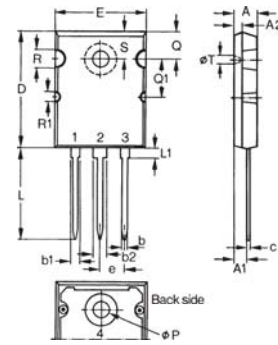
 Note 1: Pulse test, $t \leq 300\ \mu\text{s}$, duty cycle $\leq 2\%$
TO-264 AA Outline

Dim.	Millimeter		Inches	
	Min.	Max.	Min.	Max.
A	4.82	5.13	.190	.202
A1	2.54	2.89	.100	.114
A2	2.00	2.10	.079	.083
b	1.12	1.42	.044	.056
b1	2.39	2.69	.094	.106
b2	2.90	3.09	.114	.122
c	0.53	0.83	.021	.033
D	25.91	26.16	1.020	1.030
E	19.81	19.96	.780	.786
e	5.46 BSC		.215 BSC	
J	0.00	0.25	.000	.010
K	0.00	0.25	.000	.010
L	20.32	20.83	.800	.820
L1	2.29	2.59	.090	.102
P	3.17	3.66	.125	.144
Q	6.07	6.27	.239	.247
Q1	8.38	8.69	.330	.342
R	3.81	4.32	.150	.170
R1	1.78	2.29	.070	.090
S	6.04	6.30	.238	.248
T	1.57	1.83	.062	.072

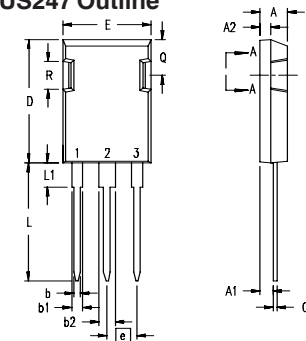
PLUS247 Outline

 Terminals: 1 - Gate
 2 - Drain (Collector)
 3 - Source (Emitter)
 4 - Drain (Collector)

Dim.	Millimeter		Inches	
	Min.	Max.	Min.	Max.
A	4.83	5.21	.190	.205
A1	2.29	2.54	.090	.100
A2	1.91	2.16	.075	.085
b	1.14	1.40	.045	.055
b1	1.91	2.13	.075	.084
b2	2.92	3.12	.115	.123
C	0.61	0.80	.024	.031
D	20.80	21.34	.819	.840
E	15.75	16.13	.620	.635
e	5.45 BSC		.215 BSC	
L	19.81	20.32	.780	.800
L1	3.81	4.32	.150	.170
Q	5.59	6.20	.220	0.244
R	4.32	4.83	.170	.190

IXYS reserves the right to change limits, test conditions, and dimensions.

IXYS MOSFETs and IGBTs are covered by one or more of the following U.S. patents:	4,835,592	4,931,844	5,049,961	5,237,481	6,162,665	6,404,065 B1	6,683,344	6,727,585
	4,850,072	5,017,508	5,063,307	5,381,025	6,259,123 B1	6,534,343	6,710,405 B2	6,759,692
	4,881,106	5,034,796	5,187,117	5,486,715	6,306,728 B1	6,583,505	6,710,463	6,771,478 B2

Fig. 1. Output Characteristics
@ 25 Deg. C

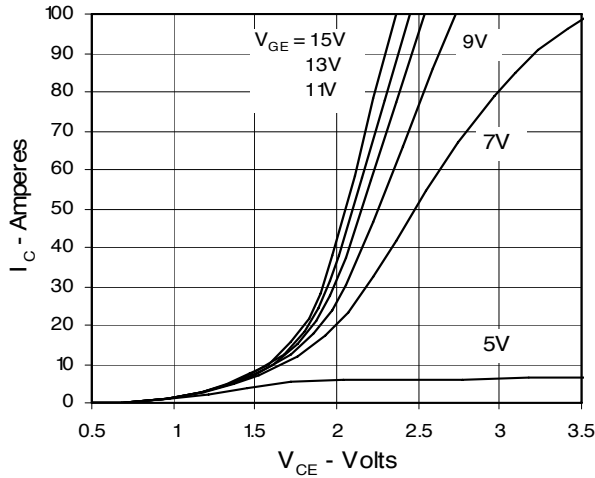

Fig. 2. Extended Output Characteristics
@ 25 deg. C

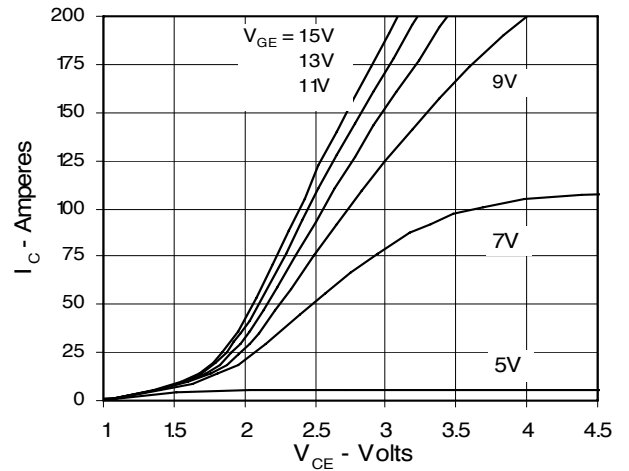

Fig. 3. Output Characteristics
@ 125 Deg. C

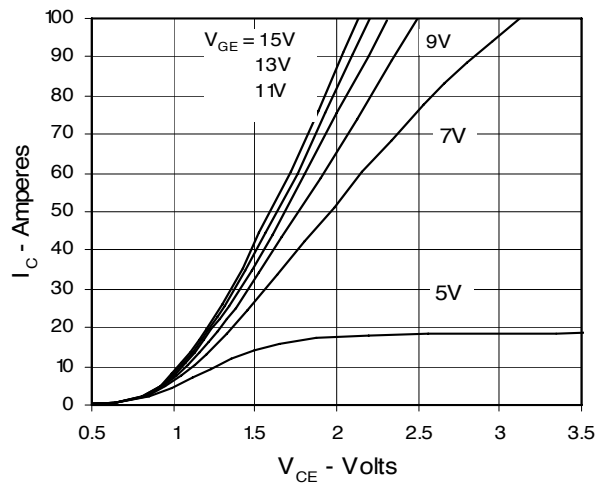

Fig. 4. Temperature Dependence of $V_{CE(sat)}$

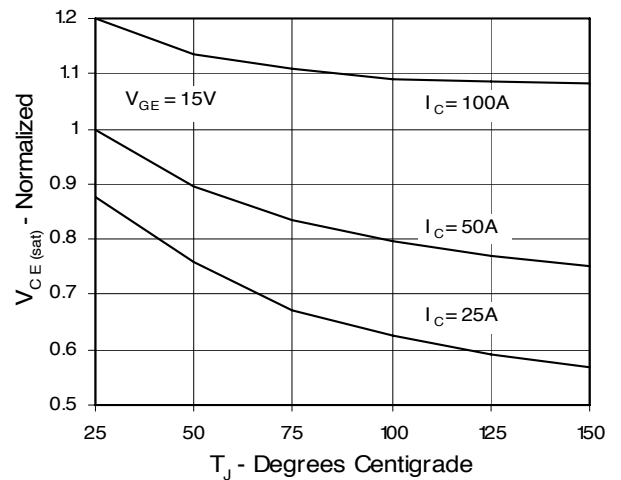

Fig. 5. Collector-to-Emitter Voltage vs. Gate-to-Emitter voltage

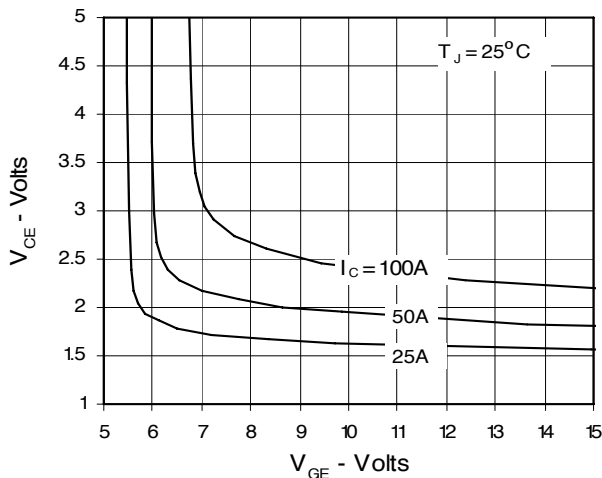

Fig. 6. Input Admittance

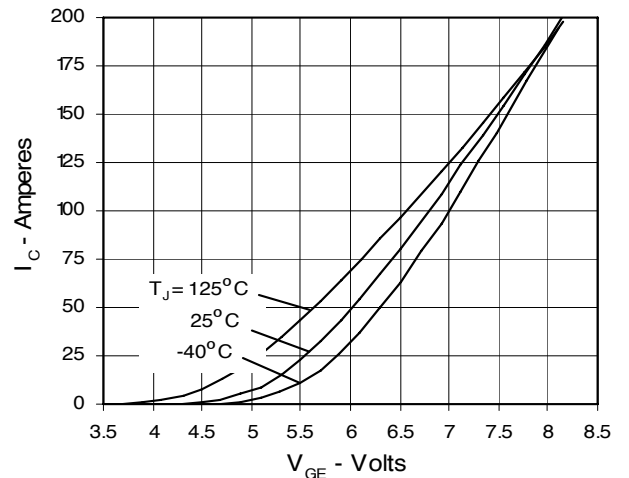

Fig. 7. Transconductance

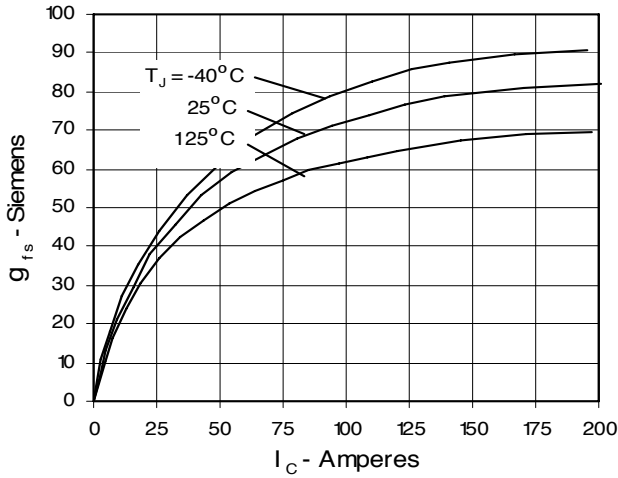

Fig. 8. Dependence of E_{off} on R_G

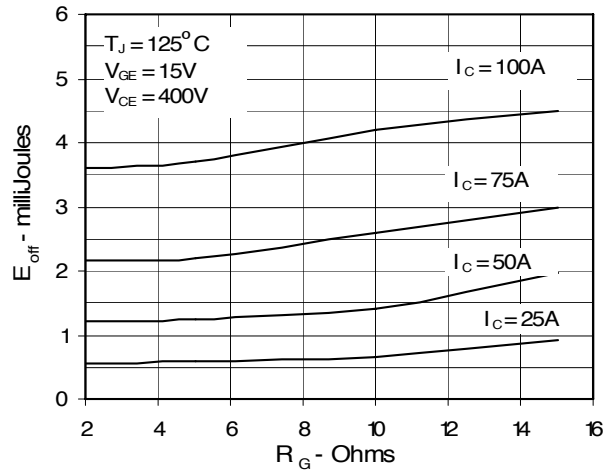

Fig. 9. Dependence of E_{off} on I_C

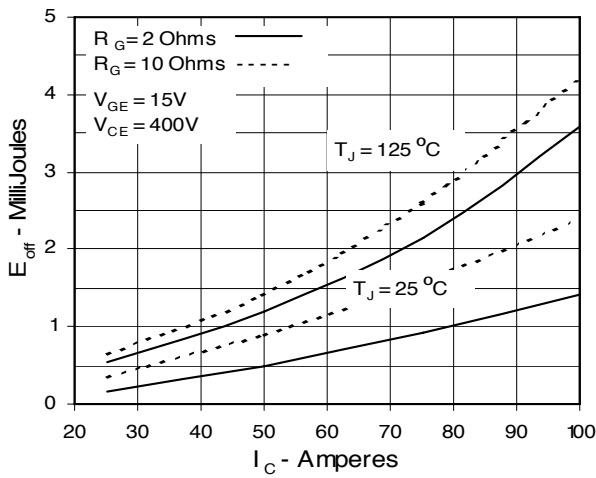

Fig. 10. Dependence of E_{off} on Temperature

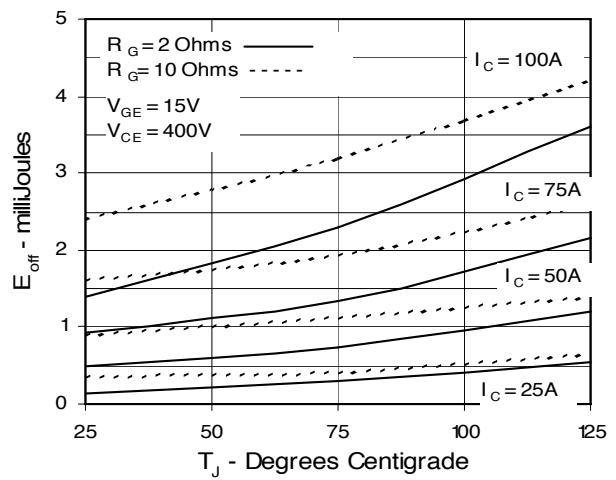

Fig. 11. Gate Charge

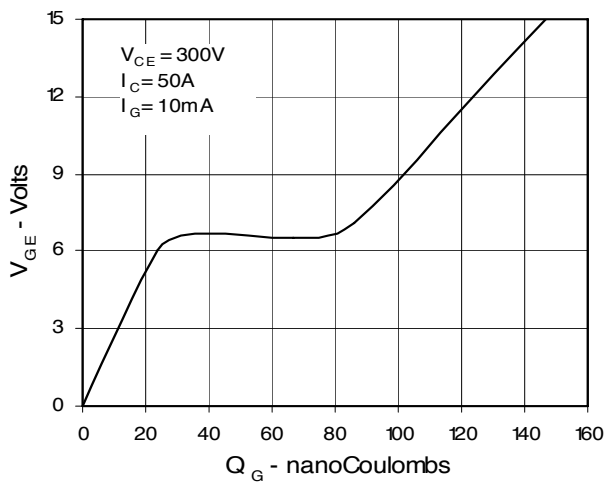

Fig. 12. Capacitance

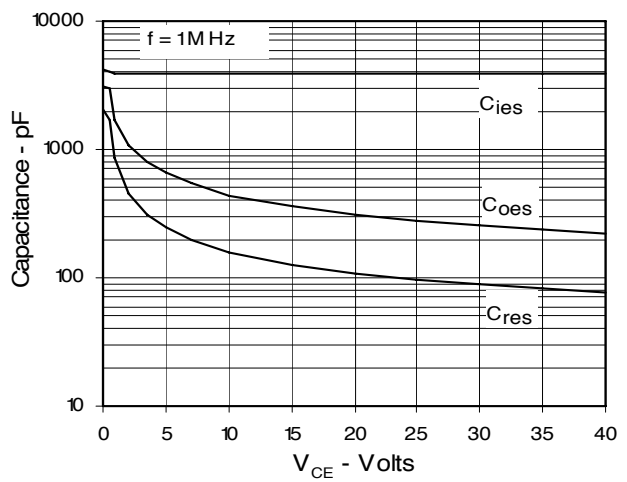
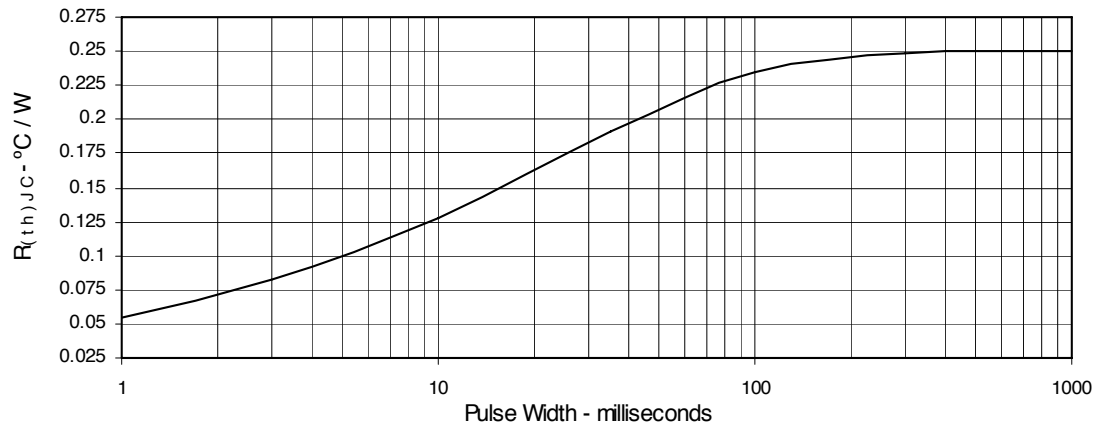

Fig. 13. Maximum Transient Thermal Resistance



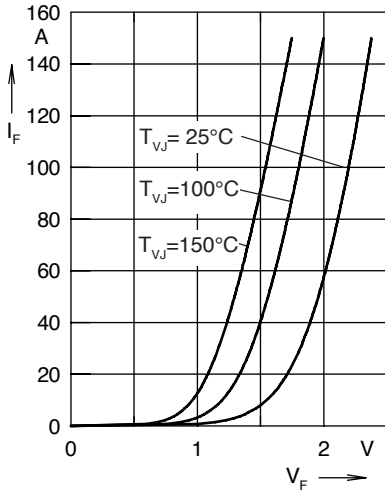

Fig. 14. Forward current I_F versus V_F

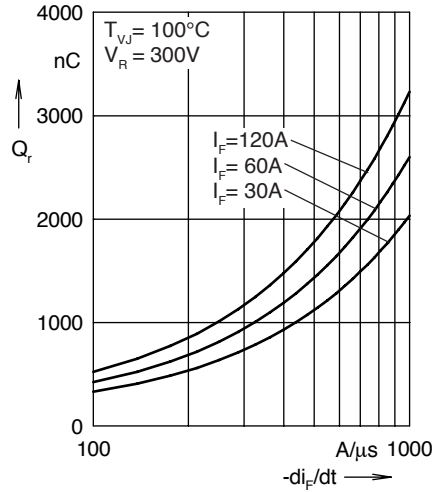

Fig. 15. Reverse recovery charge Q_r versus $-di_F/dt$

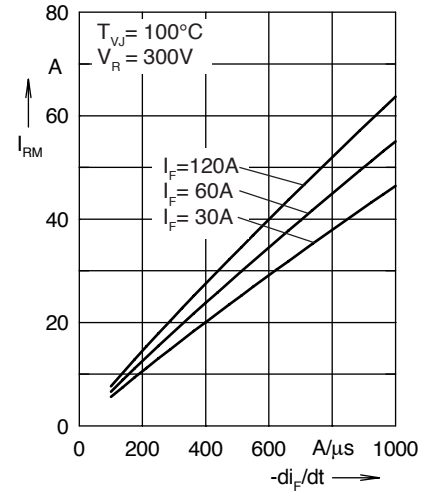

Fig. 16. Peak reverse current I_{RM} versus $-di_F/dt$

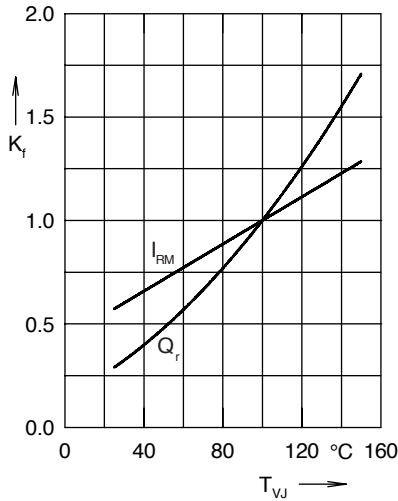

Fig. 17. Dynamic parameters Q_r , I_{RM} versus T_{VJ}

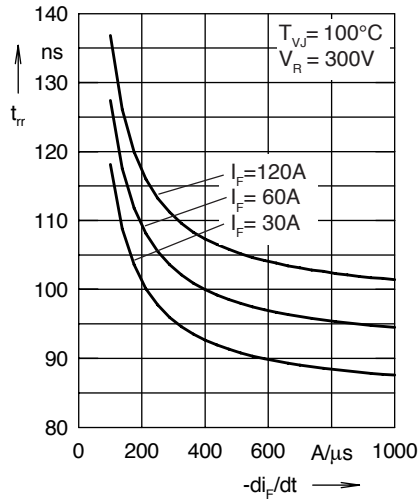

Fig. 18. Recovery time t_{tr} versus $-di_F/dt$

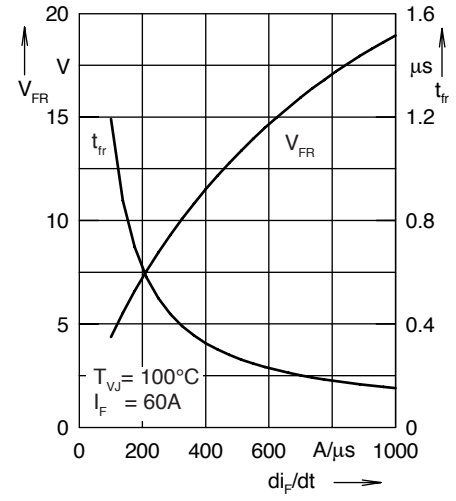

Fig. 19. Peak forward voltage V_{FR} and t_{fr} versus di_F/dt

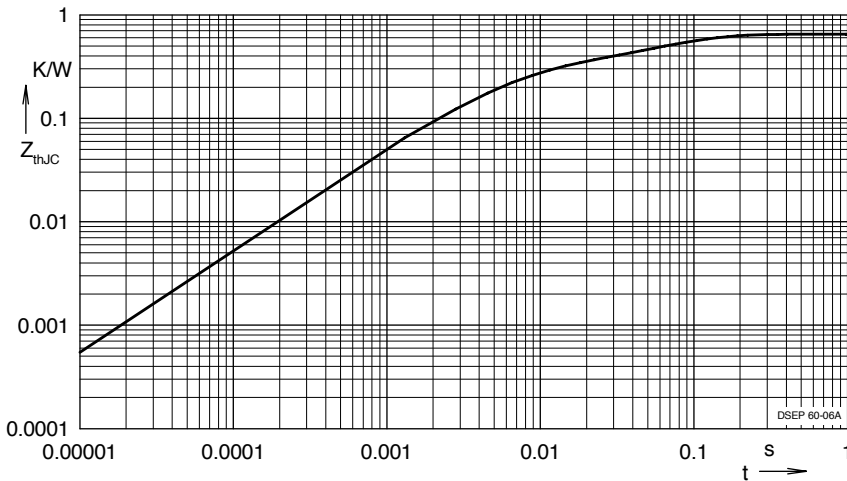

Fig. 20. Transient thermal resistance junction to case

Constants for Z_{thJC} calculation:

i	R_{thi} (K/W)	t_i (s)
1	0.324	0.0052
2	0.125	0.0003
3	0.201	0.0385

Note: Fig. 15 through Fig. 20 show typical values